



## Evaluating the Performance and Environmental Impact of Electric Vehicles with Old Battery Pack: A Well-to-Wheel Analysis

Mohammad Hossein Nahani<sup>1</sup>, Gholam Reza Molaeimanesh<sup>2</sup>, Masoud Dahmardeh<sup>2\*</sup>

<sup>1</sup> Ph.D. student of Automotive Engineering, Iran University of Science & Technology, Tehran, Iran

<sup>2</sup> School of Automotive Engineering, Iran University of Science & Technology, Tehran, Iran

### ARTICLE INFO

#### Article history:

Received : 15 Jun 2024

Accepted: 13 Oct 2024

Published: 3 Nov 2024

#### Keywords:

Li-ion Battery

Battery Aging

Electrical Vehicle

Life Cycle Assessment

### ABSTRACT

The transition from traditional internal combustion engine vehicles to electric vehicles is in progress. With their high energy density, low self-discharge rates, long cycle life, and absence of memory effects, lithium-ion batteries have become the primary power source for alternative vehicles. Throughout the battery's lifespan, its performance or health gradually deteriorates due to irreversible physical and chemical changes. Depending on the specific aging mechanisms, a battery may lose capacity or face increased internal resistance. Growing awareness of the importance of environmental protection and the potential implications associated with products and services has spurred interest in developing methods to better understand and address these impacts. Life cycle assessment is a method used to examine the environmental effects associated with all stages of product production. This study compares the operational conditions of an electric vehicle equipped with both new and old battery packs. The performance difference indicates that the vehicle with the aged battery has 17% less capacity, operates over 20% weaker in range, and its ohmic resistance increases by up to 150%. From a well-to-wheel perspective, using an electric vehicle with an old battery could result in a 2% increase in carbon dioxide emissions, reaching 56.638 g CO<sub>2</sub> equivalent per kilometer.

## 1. Introduction

As global warming, urban pollution, and fossil fuel shortages become increasingly serious, countries around the world are eager to replace traditional fuel-powered vehicles with new energy vehicles to mitigate resource crises and reduce greenhouse gas emissions [1-2]. Electric vehicles (EVs) have created significant development opportunities in this context, leading various countries to adopt market promotion schemes to electrify transportation. Mercedes-Benz has declared that its cars will be completely electric by 2030 [3]. In 2020, 3 million alternative vehicles were sold worldwide, and projections suggest that this number will go up to 10 million, 28 million,

and 56 million by 2025, 2030, and 2040, respectively. [4]. Lithium-ion batteries are the primary power source for alternative vehicles because of their high energy density, low self-discharge rates, long cycle life, and absence of memory effects [5].

According to Figure 1, the demand for electric vehicle batteries worldwide was 120 GWh in 2019 and is predicted to increase to 680 GWh and 1,525 GWh by 2025 and 2030, respectively. China is currently the biggest market for electric vehicles in the world, and estimates suggest that China's demand for electric vehicle batteries will reach 740 GWh by 2030 [6].

\*Corresponding Author

Email Address: [mdahmardeh@iust.ac.ir](mailto:mdahmardeh@iust.ac.ir)  
<https://doi.org/10.22068/ase.2024.683>

## Evaluating the Performance and Environmental Impact of Electric Vehicles with Old Battery Pack: A Well-to-Wheel Analysis

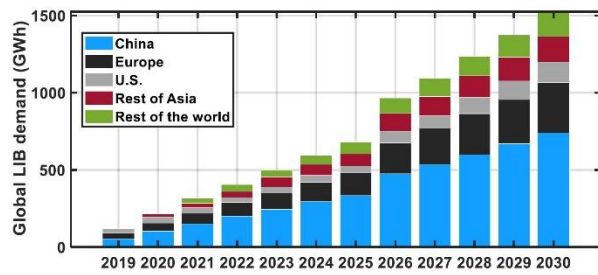

**Figure 1:** Demand request for global lithium-ion battery in electric vehicles [6]

In order to ensure safety, it is necessary to retire lithium-ion batteries from electric vehicles after 8 to 15 years or when their capacity drops to 70-80% of their initial capacity. Estimates suggest that passenger electric vehicle batteries that are retired will weigh approximately 13 million tons worldwide between 2021 and 2030 [7].

Technical literature identifies battery aging as calendar aging and cycle aging. Temperature and state of charge are the main factors that determine calendar aging. Charge/discharge current rates and cutoff voltages affect cycle aging in addition to these factors. Battery aging has been viewed as a result of charge/discharge current rates, but many articles have agreed that higher current rates lead to faster aging. A battery can lose capacity or experience increased internal resistance depending on its specific aging mechanisms. According to numerous studies, battery aging is caused by chemical changes at the electrode/electrolyte interface in the negative electrode, which is the main cause for both calendar and cycle aging. The solid electrolyte interface (SEI) is the primary cause of capacity loss and increased resistance. The aging process is also influenced by other factors, such as changes in active material and electrode composition, but to a lesser extent. The initial charge/discharge cycles initiate the formation of the SEI, and it continues to undergo transformation and growth in subsequent cycles and even during storage [8].

Most electric vehicle batteries come with an 8-year warranty or a driving limit of 160,000 km. Manufacturers in California are required to extend the warranty to 10 years or 240,000 km. The goal of the U.S. Advanced Battery Consortium is a 15-year battery life warranty and 1,000 cycles by 2020. Research laboratories have reported up to 2,000 full cycles. Laboratory tests yield better results compared to real-world conditions. The secret to the long lifespan of batteries in vehicles is their larger size, which allows them to operate mainly in a mid-range, offering ample "Grace Capacity" for both upper and lower limits. Partial usage reduces battery stress but underutilizes

valuable energy storage. The larger size also adds cost and weight, but this extra capacity is ultimately utilized when capacity diminishes. Charging the battery only up to 80% and discharging it down to 20%, as is typically done in vehicle batteries, uses only 60% of its capacity. Figure 2 illustrates the driving range of a new battery, highlighting the additional headroom capacity in green. After approximately 900 cycles, this excess capacity begins to deplete, leading to battery aging. As shown in the chart, adjusting the control strategy can extend battery life by adding more headroom capacity, but this results in a reduced driving range [9].

The creation of batteries leads to the exploitation of natural resources in large amounts. Lithium extraction and processing is a significant environmental impact because it requires significant amounts of energy and water. In addition, the manufacturing and assembly of batteries necessitates substantial energy inputs, which lead to the emission of toxic gases. Finally, the safe disposal of waste batteries with minimal environmental impact has become a global issue [10].

Recently, life cycle assessment (LCA) of batteries has gained increased attention. This involves collecting and evaluating the inputs, outputs, and potential environmental impacts of a product or service throughout its life cycle. In recent years, studies on LCA related to electric vehicles and lithium-ion batteries can be summarized as follows: (1) the environmental characteristics of various automotive propulsion technologies (such as battery electric vehicles, hybrid electric vehicles, plug-in hybrids, and fuel cell electric vehicles) are primarily examined in terms of carbon emissions, environmental impacts, and water footprints using LCA methods. (2) The impact of different battery types and materials on the environment during the production or recycling stages is compared through LCA [11].

This study presents the behavior of an electric vehicle equipped with both new and old batteries. The performance of the vehicle and battery is compared to assess the impact of battery aging on vehicle usage. Furthermore, due to changes in energy consumption and operational conditions, the detrimental environmental impacts of using an old battery compared to a new one will also be analyzed from a life cycle perspective.

The innovation in this research lies in integrating the concepts of battery life and the well-to-wheel assessment of electric vehicles. The interplay between these topics can be significant.

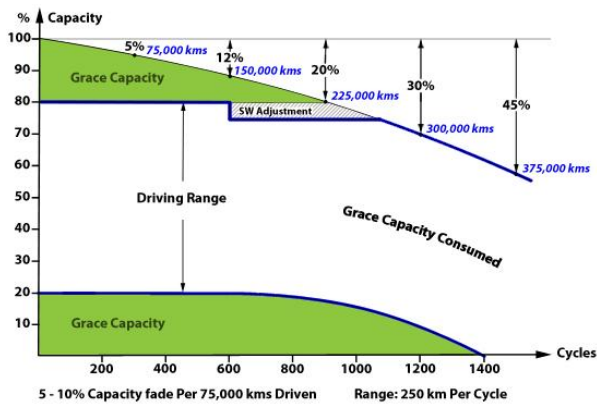

Figure 2: Energy range of aging lithium-ion battery in electric vehicles [9]

## 2. Methodology

This study consists of two main sections: vehicle performance simulation and life cycle assessment. The results and outputs from the simulation serve as input data for the life cycle assessment section. The following outlines the methodology for these two components.

### 2.1. Vehicle Performance Simulation

Initially, to facilitate a comparison between the performance of electric vehicles with new and old batteries, a one-dimensional model of the electric vehicle must be established for the simulation process.

Figure 3 depicts the model used in the Siemens Simcenter AMESIM software, which includes a vehicle, a driver, a complete vehicle network with the associated battery controls, and an electric motor. The relevant vehicle and battery pack information is specified in Table 1. Given that an advanced equivalent circuit model is employed for the battery, the dynamic voltage behavior of the battery and the heat generated during charging and discharging are reproduced (Figure 4).

All battery model parameters can be inferred from measurements without the need to disassemble the cells [12]. The electrical parameters of the battery were identified from experimental measurements provided by existing tests. All this data was obtained experimentally by IFPEN, a reputable research and educational organization in the fields of energy, transportation, and the environment [12].

The driver operates the vehicle according to the specifications of the New European Driving Cycle until the battery is nearly depleted. The discharge criterion adopted in this study is a fixed level of 10% state of charge.

Table 1: Parameters considered for vehicle and battery

Vehicle Properties	Amount	Unit
Class	Compact car	
Weight	1000	Kg
Drag Coefficient	0.3	-
Front Area	2	M <sup>2</sup>
Wheel Diameter	15	in
Battery Pack Properties		
Cell	LIFPO4 (LFP-C)	
Numbers	1000	
Cell Capacity	2.3	Ah
Battery Pack Voltage	320	V
Pack Architecture	100 S 10 P	

When the battery’s charge level reaches 10%, the simulation automatically stops. This setup allows for the independent assessment of battery aging in an old vehicle compared to a new vehicle. The New European Driving Cycle represents urban driving conditions for the first 800 seconds and extra-urban conditions for the last 400 seconds, as illustrated in Figure 5 [13]. This driving cycle is utilized for the simulation mission.

The new battery pack consists of new cells, while the old battery has lost 17% of its capacity due to aging, leaving it with a remaining capacity of 1.9 ampere-hours.

The experimental data is from the available information from tests by IFPEN on the battery pack with the information in Table 1. This data includes OCV tables under different conditions for new and old batteries. To ensure the validity of the experimental data and the credibility of this work, the electrical parameters provided by the identification tool can be compared. For instance, the open-circuit voltage remains relatively unchanged with age, as shown in Figure 6.

The current model is an integrated representation of the vehicle, incorporating its most important systems as subsystems. It effectively simulates the vehicle's performance. The primary purpose of this model is to analyze the impact of changing the battery from a new to an old condition. Increasing the complexity of the model would only result in higher computational costs without providing significant benefits. However, this model has limitations. For example, it does not account for the

# Evaluating the Performance and Environmental Impact of Electric Vehicles with Old Battery Pack: A Well-to-Wheel Analysis

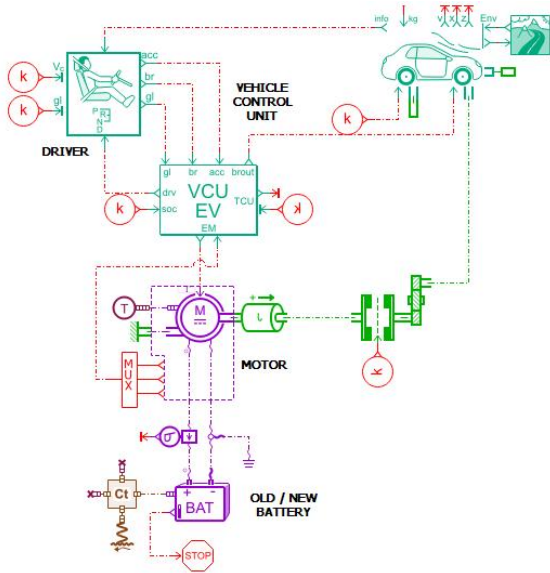

**Figure 3:** EV model design in AMESIM

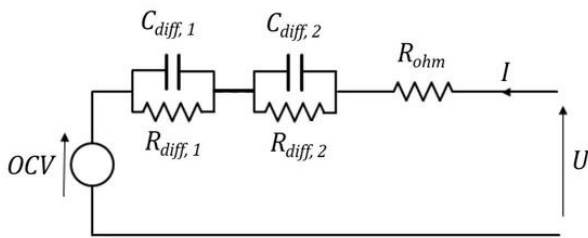

**Figure 4:** Equivalent circuit model for battery cell

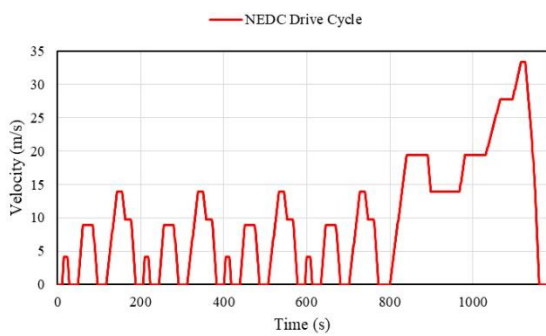

**Figure 5:** NEDC driving cycle

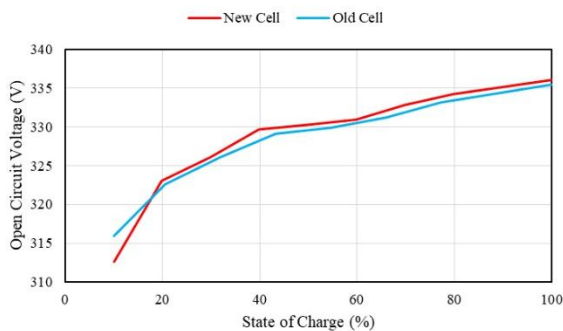

**Figure 6:** Validation of OCV versus charge level for a new battery and an old battery

vehicle's cooling system dynamics or the effects of varying weather conditions.

## 2.1.1. Model Assumptions

Every model inherently incorporates simplifications and assumptions to balance accuracy with practicality. The present model is no exception, adopting several key assumptions. Notably, it disregards all factors influencing vehicle performance except the battery current required to meet the driving cycle's speed demands. Furthermore, the battery modeling relies exclusively on empirical data and preexisting tables corresponding to both new and aged battery packs, without incorporating dynamic or physics-based simulations. The electric motor's operational conditions are simplified by assuming a constant efficiency, independent of load or rotational speed variations. Environmental factors such as temperature fluctuations and altitude changes are also excluded from the analysis. Additionally, the model does not account for battery charging dynamics or associated conditions. These assumptions streamline the computational framework while focusing on the primary variables under investigation.

## 2.1.2. Model Validation

To validate the present model, the vehicle's compliance with the driving cycle has been examined. The present vehicle must be able to follow the driving cycle with all the defined subsystems. The vehicle's speed relative to the driving cycle has been examined in Figure 7. The highest error in speed is about 1.3%, which occurs at the moment of severe braking acceleration. In general, the error is very low throughout the route, and the overlap of the vehicle speed values in the present model and the driving cycle is evident in the diagram.

## 2.2. Life Cycle Assessment

The life cycle of a vehicle is influenced by various factors, including technical specifications, resource and energy supply, the usage phase, and production and recycling technologies (Figure 8).

In vehicles, IC engines internal combustion engines are typically chosen as the propulsion system, making fossil fuels the primary resource during the usage phase.

Conversely, in electric vehicles, the main resources are utilized during the production phase, as battery construction, storage systems, and propulsion generation depend on these resources [14].

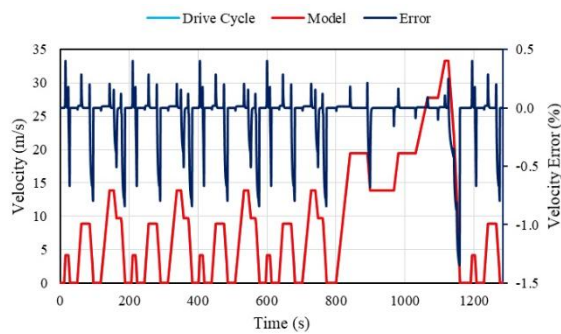

**Figure 7:** Validation of vehicle model versus drive cycle velocity

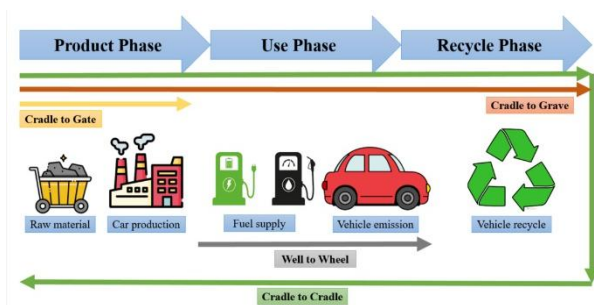

**Figure 8:** Scope and boundary of the vehicle life cycle system

One assessment method involves analyzing the environmental impacts generated throughout the entire life cycle, known as life cycle assessment (LCA). LCA addresses environmental aspects and potential impacts, such as resource use and environmental consequences of emissions, across the life cycle of a product from raw material extraction to processing, production, consumption, end-of-life treatment, recycling, and final disposal, essentially from cradle to grave.

Generally, four phases exist in life cycle assessment: goal and scope definition, inventory analysis, impact assessment, and interpretation [15].

### 2.2.1. Goal and Scope Definition

The goal and scope definition phase includes system boundaries and the level of detail for an LCA study, which depend on the subject and intended use of the study. The depth and breadth of the LCA can vary significantly based on its specific objectives [15].

Given the complex nature of modern supply chains, a broad understanding of system boundaries aids in analyzing which processes lead to the greatest environmental concerns. System boundaries, defined based on initial assumptions, intended applications, and shortcut criteria, determine which processes should be included in

the LCA. The functional unit establishes references to clarify which inputs and outputs can be correlated, enabling comparisons between different systems. The timeframe for conducting the LCA can negatively impact results, as energy consumption varies over time. Additionally, the quality of the assessment results is directly related to the quality of the data used [14].

In this study, the considered scenarios involve comparing the environmental impact of traveling 1 kilometer by a vehicle using both a new and an old battery, analyzed from a well-to-wheel perspective. This system boundary encompasses the vehicle's usage phase and its fuel supply. The significance of assessing the detrimental environmental effects that arise during vehicle operation cannot be overlooked.

### 2.2.2. Inventory Analysis

This phase involves collecting data and computational procedures to quantify the inputs and outputs associated with a product system necessary to meet the defined study objectives [15].

To obtain values for the various sections of the system, researchers have several methodologies at their disposal. These range in credibility and usefulness, including direct measurements, modeling and simulation, obtaining information from reliable sources and references, rough calculations, and finally, using free databases available in software. In this study, all relevant figures regarding the vehicle's operational time are extracted from the simulations conducted in the previous section. The electricity consumption is calculated based on the energy used during vehicle operation.

Given the chosen system boundary, only the production of electricity for the vehicle's energy supply is considered significant. Therefore, data related to this aspect is sourced from the energy balance of Iran. Table 2 displays the amounts of pollutants produced in Iran's power generation sector [16].

### 2.2.3. Impact Assessment

This phase aims to evaluate the significance of potential environmental impacts using the results from the inventory analysis phase. Generally, this stage involves correlating the inventory data with specific environmental impact categories and indicators, thereby identifying these impacts [15].

### 2.2.4. Interpretation

OpenLCA software is a powerful open-source tool that facilitates life cycle assessment. The data

## Evaluating the Performance and Environmental Impact of Electric Vehicles with Old Battery Pack: A Well-to-Wheel Analysis

obtained in the previous phase is entered into the environmental impact category database. This database is currently maintained under the guidance of the European Commission and its Joint Research Centre, with the latest version being 3.1 (as of June 2023) [17].

Environmental impacts are categorized into midpoint and endpoint categories, and various studies may present different results depending on the type of assessment and chosen impact evaluation method. For this study, the selected method for assessment is the environmental footprint (midpoint indicator). Normalization and weighting procedures are considered standard based on the chosen assessment type. PEF standard weighting and normalization factors for midpoint indicators chosen to use for this assessment shown in table 3.

The final stage of the life cycle assessment involves considering the findings from the inventory analysis and impact assessment together. This interpretation phase presents results aligned with the defined objectives and scope, explains any limitations, and provides recommendations. The main goal of this phase is to determine the reliability of the final results and communicate them fairly and accurately [15].

### 3. Results

The results can be divided into two categories: first, the findings related to the simulation of vehicle performance with new and old batteries; second, the results concerning the life cycle assessment.

#### 3.1. Vehicle Performance Simulation Results

Examining vehicle behavior due to changes in battery performance conditions is crucial. As shown in Figure 9, the results indicate that the distance traveled by the vehicle decreased from 70.2411 km to 56.5938 km due to battery aging.

This reduction is attributed to the loss of capacity and increased internal resistance, which necessitates higher currents to meet the electric vehicle's power demands.

Ohmic resistance is the sum of the electrolyte resistance, current collector resistance, active mass resistance, and the resistance between the current collector and the active mass. Theoretically, the voltage across the ohmic resistance follows Ohm's law based on the battery current. Diffusion resistance determines the ability of a material to conduct electricity through diffusion.

**Table 2:** The emission of polluting gases in the power plant sector of Iran (thousand tons) [16]

Year/ Gas	CH4	CO2*	CO	SO3	SO2	NOx	N2O
2012	4/2	174	161	5/32	823	629	0/69
2013	4/7	179	162	6/57	910	678	0/8
2014	4/2	177	177	4/58	627	651	0/65
2015	4/2	174	162	4/15	437	627	0/63
2016	3/6	171	160	2/48	295	641	0/48
2017	3/7	182	156	2	239	651	0/47
2018	3/7	184	151	2/25	239	672	0/48
2019	4/1	195	146	3/75	396	740	0/6
2020	4/5	200	141	3/85	408	736	0/64

\* The values in this column are in million tons.

**Table 3:** Normalization and weighting of environmental footprint midpoint indicator

Mid-Indicator Impact Category	Normalization Value	Weighting factor
Climate Change	-	-
Eutrophication marine	28.3	0.0312
Acidification	55.5	0.0664
Photochemical ozone formation	40.6	0.051
Resource use, fossils	65300.0	0.0892

Figures 10 and 11 illustrate the changes in internal resistance of the battery pack. The ohmic resistance in the old battery is greater than in the new one. After aging by 17%, the ohmic resistance of the old battery increases by up to 150% compared to the new battery. However, the behavior of diffusion resistance changes differently. At high charge levels, the old battery pack exhibits up to 100% higher diffusion resistance than the new pack, but at low charge levels, the new battery shows significantly higher resistance (about four times) in electrical diffusion.

Thermal behavior of the battery is also affected by aging. The increase in internal resistances leads to higher heat generation due to the Joule effect, which raises the temperature of the battery pack. Figure 12 shows the temperature changes inside the battery for the two tested conditions. This altered thermal behavior results in a higher temperature in the old battery pack (about 2 °C for the same specifications). Importantly, this temperature

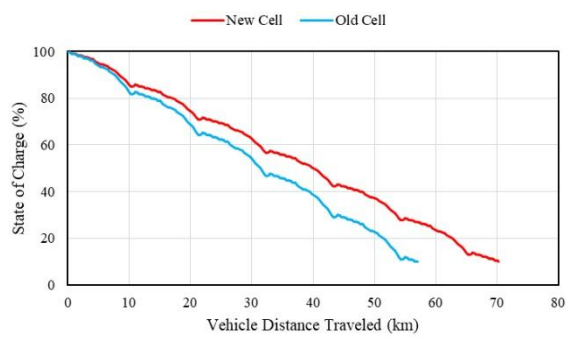

**Figure 9:** Comparison of the distance traveled by the vehicle with new and old battery

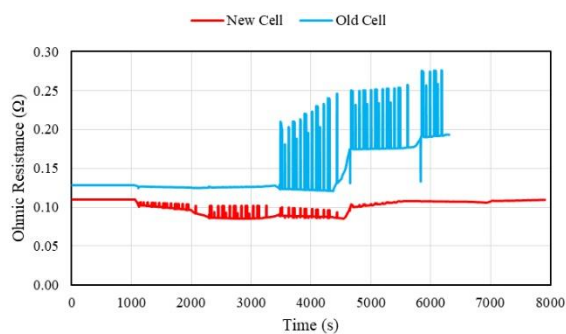

**Figure 10:** Comparison of changes in ohmic resistance of vehicle battery pack with new and old battery

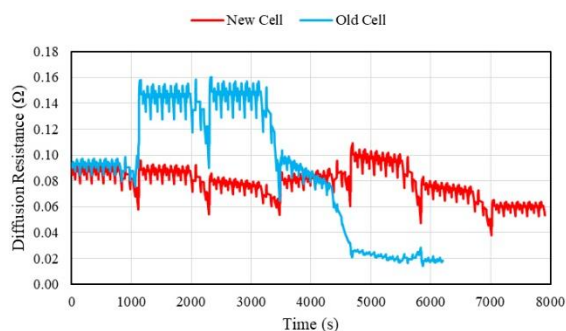

**Figure 11:** Comparison of changes in diffusion resistance of vehicle battery packs with new and old battery

increase also accelerates the aging process. Consequently, different thermal management strategies should be applied based on the battery's state of health.

Finally, the energy consumption per kilometer traveled by the vehicle is crucial for enabling the life cycle assessment of the vehicle. According to the obtained results, the vehicle with the new battery consumes 95.2576 Wh/km, while the vehicle with the old battery consumes 96.689 Wh/km.

### 3.2. Life Cycle Assessment Results

The life cycle assessment from well to wheel for electric vehicles with new and old battery packs presents results shown in Table 4. These values are derived from the conducted research, and all examined impact categories fall under intermediate effects, including final impacts on environmental degradation, human health, and resource and water usage. The assessment provided is a comprehensive evaluation of the vehicle's use phase.

Figure 13 displays a comparison of defined scenarios for the impact of climate change. The use of old batteries can increase the equivalent carbon dioxide emissions during the vehicle's use phase by up to 2%.

Marine eutrophication is defined as the reaction of a marine ecosystem to an excess of a limiting nutrient. The use of old batteries can be up to 1.5% more detrimental in this category.

Acidification describes a process where the addition of nitrogen or carbon dioxide reduces the pH of soils or oceans, which can have various direct and indirect effects on plant growth. An electric vehicle with a new battery contributes up to 1.4% less to environmental acidification compared to the same vehicle with an old battery.

Photochemical ozone formation at ground level, resulting from the photochemical oxidation of volatile organic compounds and carbon monoxide in the presence of nitrogen oxides and sunlight, is linked to air pollution that can lead to respiratory issues. An electric vehicle with an old battery can exacerbate this problem by 1.5%.

Finally, one of the most critical metrics for comparison and evaluation is the energy required over the life cycle. A vehicle under the same operating conditions, but with new and old battery packs, will show a difference of approximately 12 J/km traveled.

### 4. Conclusion

The replacement of traditional fuel vehicles with electric vehicles is underway, with lithium-ion batteries being the most crucial component of these alternatives. One of the key parameters under investigation for batteries is their state of health and lifespan. Battery modeling can significantly assist researchers in studying battery behavior and, subsequently, vehicle performance. Additionally, the environmental impacts of different vehicle types and their detrimental effects are increasingly gaining attention. Life cycle assessment is one of the best methods to examine these concerns.

## Evaluating the Performance and Environmental Impact of Electric Vehicles with Old Battery Pack: A Well-to-Wheel Analysis

**Table 4:** The results of the evaluation of the well to wheel of a vehicle with a new and old battery per 1km

Mid-Indicator Impact Category	Unit	EV with New Battery	EV with Old Battery
Climate Change	kg CO <sub>2</sub> eq	0/055799341	0/056637827
Eutrophication marine	kg N eq	0/0000796	0/0000809
Acidification	mol H+ eq	0/000301543	0/000306074
Photochemical ozone formation	kg NMVOC eq	0/000215919	0/000219163
Resource use, fossils	MJ	0/787587446	0/799422361

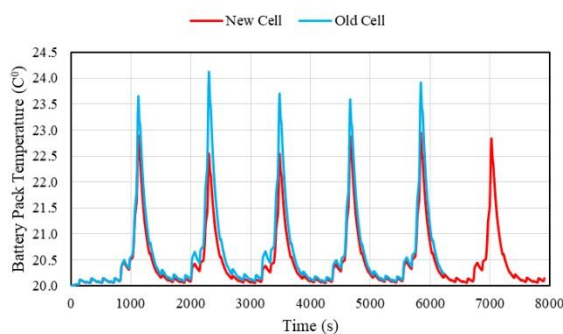

**Figure 12:** Comparison of temperature changes of vehicle battery pack with new and old battery

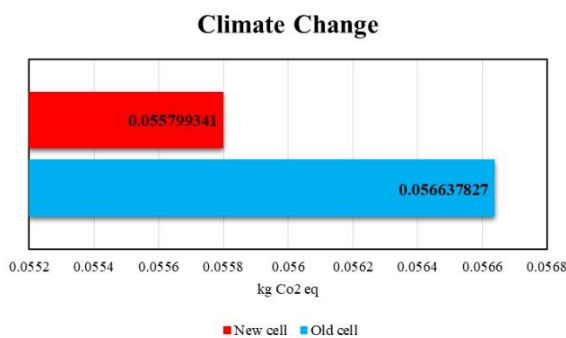

**Figure 13:** Comparison of climate change for vehicle with new and old battery

This study analyzed the effects of using both new and old battery packs on vehicle performance, alongside an environmental assessment of the vehicle's use phase. Based on the results, the following points can be highlighted:

- ✓ As batteries age, various resistance values significantly increase. The lost capacity and increased resistance in batteries nearing the end of their usable life for vehicles are noteworthy.

- ✓ The use of old batteries not only reduces vehicle range but also impacts the environmental effects identified within the well-to-wheel system boundary, contributing to environmental degradation, human health risks, and increased resource consumption.
- ✓ Implementing battery thermal management systems in vehicles is essential, as the increased temperature resulting from battery aging can accelerate the aging process further. These systems can play a crucial role in extending battery life.
- ✓ As batteries age, in addition to reduced vehicle range, the energy required for a fixed distance also increases, which, from a life cycle perspective, leads to heightened environmental impacts.
- ✓ The necessity for empirical data obtained from battery tests is unavoidable for creating more accurate and appropriate models. Each lithium-ion battery model, with its unique shapes and components, also requires specific data.
- ✓ The most significant factor affecting the life cycle of electric vehicles is the system boundary from cradle to grave of the vehicle's battery. This section addresses the impacts generated during the production of lithium-ion batteries, which accounts for substantial amounts.

Suggestions for continuing this research include examining various lithium-ion batteries under aging conditions, investigating the impact of different thermal management systems on the life cycle assessment from well to wheel, stepwise evaluation of lithium-ion battery aging on well-to-wheel assessments, and developing battery models and vehicle systems during vehicle performance simulation.

### References

- [1] Falcao EAM, Teixeira ACR, Sodre JR. Analysis of CO<sub>2</sub> emissions and technoeconomic feasibility of an electric commercial vehicle. *Appl Energy* 2017;193:297e307.
- [2] Bickert S, Kampker A, Greger D. Developments of CO<sub>2</sub>-emissions and costs for small electric and combustion engine vehicles in Germany. *Transport Res D-Tr E*. 2015;36:138e51.

- [3] Ma X, Azhari L, Wang Y. Li-ion battery recycling challenges. *Inside Chem* 2021.
- [4] Harvey LDD. Rethinking electric vehicle subsidies, rediscovering energy efficiency. *Energy Pol* 2020:146.
- [5] Lai X, Huang YF, Gu HH, Han XB, Feng XN, Dai HF, et al. Remaining discharge energy estimation for lithium-ion batteries based on future load prediction considering temperature and ageing effects. *Energy* 2022:238.
- [6] Martins LS, Guimaraes LF, Botelho AB, Tenorio JAS, Espinosa DCR. Electric car battery: an overview on global demand, recycling and future approaches towards sustainability. *J Environ Manage* 2021:295.
- [7] Rajaeifar MA, Ghadimi P, Raugei M, Wu Y, Heidrich O. Challenges and recent developments in supply and value chains of electric vehicle batteries: a sustainability perspective. *Resour Conserv Recycl* 2022:180.
- [8] Barcellona S, Piegari L. Effect of current on cycle aging of lithium ion batteries. *Journal of Energy Storage* 29 (2020) 101310.
- [9] Battery Aging in an Electric Vehicle (EV), Accessed 20 May 2024; <https://batteryuniversity.com/article/bu-1003a-battery-aging-in-an-electric-vehicle-ev>
- [10] Harper G, Sommerville R, Kendrick E, Driscoll L, Slater P, Stolkin R, et al. Recycling lithium-ion batteries from electric vehicles. *Nature* 2019; 575(7781):75e86.
- [11] Lai X, et al. Critical review of life cycle assessment of lithium-ion batteries for electric vehicles: A lifespan perspective. *eTransportation* 12 (2022) 100169.
- [12] Environmental studies. IFP Energies nouvelles test benches. Accessed 20 May 2024; <https://www.ifpenergiesnouvelles.com/tags/environmental-studies>
- [13] New European Driving Cycle (NEDC). Accessed 20 May 2024; [https://en.wikipedia.org/wiki/New\\_European\\_Driving\\_Cycle](https://en.wikipedia.org/wiki/New_European_Driving_Cycle)
- [14] Nahani M, Ghareghani A. The Comparison of Environmental Impacts between Electric Vehicles and Internal Combustion Vehicles in Terms of Life Cycle: Literature Review. 1st National Lithium Battery Conference (LBC2021).
- [15] ISO 14044: Environmental management - Life cycle assessment -Requirements and guidelines.
- [16] M. Shafizadeh, et al. Energy Balance. Vice President of Electricity and Energy Affairs Electricity and Energy Planning and Macroeconomics Office. Pp 258-268.
- [17] OpenLCA Nexus Free Databases. Environmental Footprints (EF). Accessed 20 May 2024; <https://nexus.openlca.org/database>